

# Electronic coffee grinder-doser

## Fiorenzato

**F64 E XGi**

**F64 EVO XGi**

**F83 E XGi**

**F71 EK XGi**

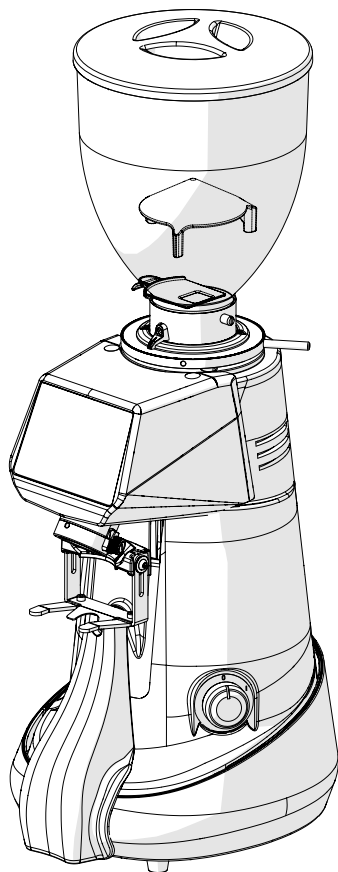

**Installation, operation  
and maintenance manual**



Read these instructions carefully before using for the first time.



TRANSLATION OF THE ORIGINAL INSTRUCTIONS

Rev\_00\_Ed\_04/2022



<b>1</b>	<b>GENERAL INFORMATION</b>	<b>5</b>
1.1	General information on the manual and how to consult it	5
1.2	Symbols used in the manual	5
1.3	Warnings for the buyer	6
1.4	Manufacturer's contact details	6
1.5	Instructions for requesting assistance	6
1.6	Warranty	7
1.7	Applicable directives	7
<b>2</b>	<b>IDENTIFICATION DATA AND TECHNICAL SPECIFICATIONS</b>	<b>8</b>
2.1	Introduction	8
2.2	Appliance identification	8
2.3	Identification of the main parts of the grinder-doser	9
2.4	Intended use	10
2.5	The models in the <b>XGi</b> line and technical specifications	10
2.6	Noise level	12
<b>3</b>	<b>SAFETY</b>	<b>12</b>
3.1	General information	12
3.2	Reasonably foreseeable misuse	12
3.3	Precautions for proper and safe use	13
3.4	Safety devices on the grinder-doser	14
3.5	Residual risks	15
3.6	Warning labels attached to the machine	16
<b>4</b>	<b>INSTALLATION</b>	<b>16</b>
4.1	Storage	16
4.2	Choosing the installation location	17
4.3	Unpacking and handling the appliance	17
4.4	Installation and mains connection	18
<b>5</b>	<b>USING THE GRINDER-DOSER</b>	<b>19</b>
5.1	Machine controls	19
5.1.1	Switch	19
5.2	Preparing to use the grinder-doser	20
5.3	“Initial start-up” procedure	21
5.4	Operator control panel	23
5.4.1	Home page	24
5.4.2	Disabling/Enabling the <b>XGi</b> automatic weighing system	27
5.4.2.1	Disabling the <b>XGi</b> automatic weighing system	27
5.4.2.2	Activation of the <b>XGi</b> automatic weighing system	27
5.4.3	Settings Menu	28

5.4.3.1	Change grinding weights	30
5.4.3.2	Dose weight display	30
5.4.3.3	Change dose times	31
5.4.3.4	Grinding time display	31
5.4.3.5	Show statistics	32
5.4.3.6	Triple dose display	32
5.4.3.7	XGi System	33
5.4.3.8	Initial start-up	33
5.4.3.9	Display brightness	33
5.4.3.10	Screen appearance	34
5.4.3.11	Screensaver	35
5.4.3.12	Language	35
5.4.3.13	Date and time	36
5.4.3.14	Information	36
5.4.3.15	Resetting dose weights	37
5.4.3.16	Administrator password	38
5.5	Adjusting the degree of grinding	39
<b>5.6</b>	<b>XGi</b> system auto-calibration	39
5.7	Dispensing doses	40
<b>6</b>	<b>GRINDER-DOSER MAINTENANCE</b>	<b>41</b>
6.1	Routine maintenance	41
6.1.1	Cleaning the appliance	42
6.1.2	Checking the power cable status	44
6.1.3	Thoroughly cleaning the grinding blades	45
6.1.4	Shutting down the grinder-doser	45
6.1.5	Replacing the grinding blades	46
6.2	Supplementary maintenance	46
<b>7</b>	<b>ANOMALIES - CAUSES - REMEDIES</b>	<b>47</b>
<b>8</b>	<b>REQUESTING SPARE PARTS</b>	<b>51</b>

## 1 GENERAL INFORMATION

### 1.1 General information on the manual and how to consult it



**Please read this instruction manual carefully before installing and using the electronic coffee grinder-doser by Fiorenzato M.C. S.r.l. for the first time.**

This instruction manual has been drawn up in compliance with the provisions of Directive 2006/42/EC and provides all the useful information for the end user to install, adjust and use the electronic coffee grinder-doser manufactured by the company Fiorenzato M.C. S.r.l.

The content of this manual must be thoroughly read and understood before installing and using the grinder-doser. It must also be stored and kept in good condition for future reference.

The images, data, texts and descriptions included in this documentation are the property of Fiorenzato M.C. S.r.l. and reflect the state of the art of the machine at the time it was placed on the market.



**Fiorenzato M.C. S.r.l. is always looking for new solutions to improve its products and therefore reserves the right to make changes to the grinder-doser and related documentation over time without considering the products already sold to be inadequate and/or obsolete.**

A general index makes it easy to find the subject of interest, and a number of informative symbols draw the user's attention to the contents of particular interest for their own safety and for the correct use of the grinder-doser.

### 1.2 Symbols used in the manual



**WARNING - NOTE!** Indicates a warning or important note relating to specific functions and/or useful information for the user. Bear in mind the paragraphs marked with this symbol.



**GENERAL DANGER - ATTENTION!** General danger sign. Text marked with this symbol indicates that failure to follow the instructions given may result in damage to the machine and/or risk of injury to the user.



**LIVE APPLIANCE - ATTENTION!** Text marked with this symbol indicates a possible risk of electrocution. Follow the instructions provided.



**OPERATION INTENDED FOR AUTHORISED TECHNICIANS:** Text marked with this symbol indicates that the action described must be carried out by a specialised technician (technical service).

### 1.3 Warnings for the buyer

This manual, like the EC Declaration of Conformity, is an integral part of your grinder-doser and must therefore be treated and stored with care. It must be made available to all users and accompany the machine when it is moved or resold to third parties.



**In the event of loss and/or deterioration of this documentation, a copy can be obtained from the manufacturer by specifying the manual code on the back cover.**

Before allowing another user to use the coffee grinder-doser, please ensure that this person has read and understood the contents of this manual.

The instruction manual contains all the instructions and procedures for use. When correctly followed, they allow you to work safely without causing damage to yourself or to the machine.



**It is the purchaser's obligation to provide appropriate training in the use and maintenance of the coffee grinder-doser for the personnel assigned to use it.**



**The purchaser and all users of the grinder-doser must carefully observe all the specific warnings included in this manual.**

### 1.4 Manufacturer's contact details

If you have any questions, please contact Fiorenzato M.C. S.r.l. at the following address:

**Fiorenzato M.C. S.r.l.**

Via Rivale, 18 - Santa Maria di Sala (VE) - ITALY

Tel. +39/049 628716 - Fax. +39/049 8956200

info@fiorenzato.it - www.fiorenzato.it

### 1.5 Instructions for requesting assistance

For technical assistance on the machine, the user must contact the dealer from whom the appliance was purchased. For further information or clarification regarding the use and/or maintenance of the grinder-doser, **Fiorenzato M.C. S.r.l.** remains at your disposal and can be contacted at the above addresses.

## 1.6 Warranty

Fiorenzato M.C. S.r.l. provides a 24-month warranty for its products from the date of the sales invoice issued by Fiorenzato M.C. S.r.l..

During the warranty period, the manufacturer undertakes to repair or replace, free of charge, any parts and/or components that are originally faulty due to manufacturing defects.

The warranty covering the product shall become void if:

- The warnings/instructions in this manual have not been followed.
- Routine maintenance and machine cleaning operations have not been carried out by a user who has been properly instructed in the correct way to carry them out.
- Repair work has been carried out by personnel who are untrained or not authorised by the manufacturer.
- The product is used for purposes other than those specified in this manual.
- Replacements have been carried out using non-original spare parts (please note that replacements with non-original parts, in addition to invalidating the warranty, also invalidate the “Declaration of Conformity” that accompanies the appliance.
- The warranty is void in the event of damage to the appliance caused by: neglect, installation and/or use not in accordance with the instructions in this manual, poor maintenance (cleaning), damage caused by lightning and atmospheric events, incorrect power supply, overvoltage and overcurrents.

## 1.7 Applicable directives

All coffee Grinder-dosers manufactured by Fiorenzato M.C. S.r.l. have been designed and made in accordance with the essential requirements of the following EU directives:

- 2006/42/EC [*Machinery Directive*].
- 2014/35/EU [*Low Voltage Directive*].
- 2014/30/EU [*Electromagnetic Compatibility Directive*].
- 2011/65/EU [*RoHS Directive*].
- 2015/863/EU [*RoHS Delegated Directive*].
- 2012/19/EU [*WEEE Directive*].

## 2 IDENTIFICATION DATA AND TECHNICAL SPECIFICATIONS

### 2.1 Introduction

Making coffee is an art and in order to master its secrets, you need to follow precise rules. The formula for a perfect cup of espresso coffee is, indeed, very complex and the part played by the appliance is extremely important. For an excellent result and unquestionable quality, three factors must be successfully combined:

- A fine blend.
- The appropriate use of available appliances.
- The skill and professionalism of those who make it. To enjoy a good coffee, contrary to popular belief, it is not enough just to choose a particular blend.

The experience and skill of the operator in following the right procedures for preparing the drink and using the appropriate machinery greatly help to create a small masterpiece. This is why professionals attach so much importance to the espresso machine and grinder-doser. Being familiar with these appliances, keeping them in perfect working order and using them to their full potential is a skill that belongs to true coffee masters. The quality of a good espresso coffee depends on a number of operations, including grinding which plays an important role. The grinder-doser is therefore one of the basic appliances for the operator. Its structure must comply with certain characteristics: robustness, resistance and functionality, characteristics that are fully satisfied by all the grinder-dosers manufactured by **Fiorenzato M.C. S.r.l.**

### 2.2 Appliance identification

On the left side of all grinder-dosers manufactured by Fiorenzato M.C. S.r.l., an identification label is attached, on which the following data is always shown:

- Company name of Fiorenzato M.C. S.r.l.
- CE marking and year of construction.
- Any other certification markings.
- Model and serial number.
- Appliance power.
- Supply voltage and frequency required.

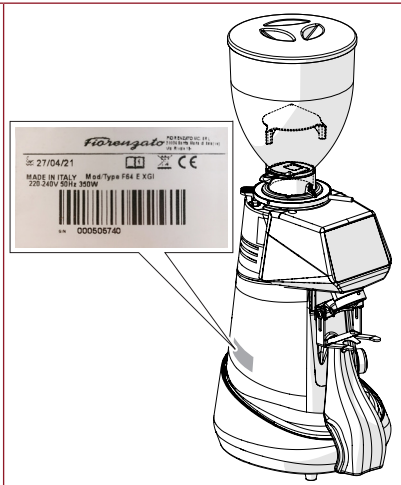



### 2.3 Identification of the main parts of the grinder-doser

Grinder-dosers consist of a machine body, with all the necessary devices for grinding coffee, and a supply hopper on the top for feeding in the roasted coffee beans to be ground.

With reference to the Fig. 1, all grinder-dosers in the **XGi** line consist of the following main parts:

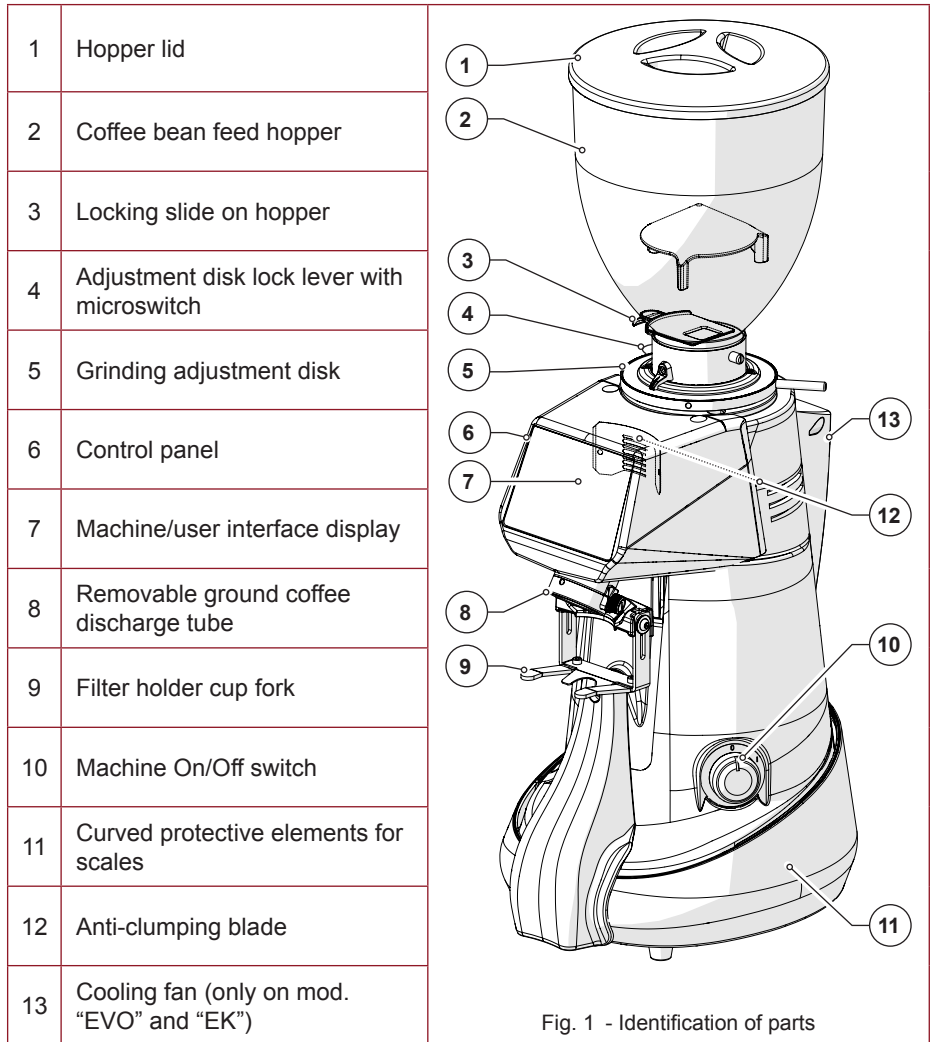

## 2.4 Intended use

This appliance has been designed exclusively for grinding roasted coffee beans. Any other use is considered improper and therefore dangerous. The manufacturer accepts no liability for any damage caused by improper or incorrect use. Do not use the appliance to grind other types of food or other materials into granules. Our grinder-dosers are intended for professional use by specialised personnel, and are not for domestic use.

## 2.5 The models in the XGi line and technical specifications

Fiorenzato M.C. S.r.l. manufactures grinder-dosers in the XGi line in the following models:

<ul style="list-style-type: none"> <li>• <b>F64 E XGi</b></li> <li>• <b>F64 EVO XGi</b></li> <li>• <b>F83 E XGi</b></li> <li>• <b>F71 EK XGi</b></li> </ul>	E		
	Fxx	EVO	XGi
		K	

### How to read the model number



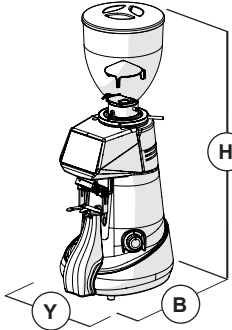

Fxx	E	EVO	K	XGi
Ø 64 mm Ø 71 mm Ø 83 mm	Electronic model	High-speed electronic model	Conical grinding blades	Integrated weighing system

The tables below show the overall dimensions and the main technical features of the XGi line of coffee grinder-dosers.

### Dimensions and weights

 <p>Fig. 2 - Dimensions</p>	Models	Dimensions [A x B x H mm]	Weight [kg]
	F64 E	255 x 635 x 320	18
	F64 EVO	255 x 635 x 320	18
	F83 E	255 x 700 x 310	20
	F71 EK	255 x 700 x 310	25

## Technical specifications

Model	F64 E XGi	F64 EVO XGi	F83 E XGi	F71 EK XGi
				
Power supply	220-240V 50 Hz	220-240V 50 Hz	220-240V 50 Hz	220-240V 50 Hz
Power [Watt]	350	350	650	850
Grinding blade type	Flat type B	Flat type C	Flat type B	Conical
Grinding blade diameter [mm]	64	64	83	71
Grinding blade rotation speed rpm	1350 at 50 Hz	1350 at 50 Hz	1350 at 50 Hz	300 at 50 Hz
	1550 at 60 Hz	1550 at 60 Hz	1550 at 60 Hz	300 at 60 Hz
Hopper capacity [kg]	1.5	1.5	1.5	1.5
Tolerance (*) on the weight of a single dose [g]	± 0.3	± 0.3	± 0.3	± 0.3
Weight (**) single dose [g]	7.5	7.5	7.5	7.5
Tolerance (*) on the weight of a single dose [g]	± 0.6	± 0.6	± 0.6	± 0.6
Weight (**) double dose [g]	14	14	14	14
Daily grinding [kg]	1÷2	2÷3	3÷7	8÷14
Frequency of grinding blade replacement in working hours (h) and in kg of ground coffee [kg]				
"Standard" grinding blades (h) - [kg]	(54) - [400]	(33) - [400]	(45) - [600]	(66) - [1200]
"Red Speed" grinding blades (h) - [kg]	(216) - [1600]	(132) - [1600]	(180) - [2400]	(264) - [4800]
<b>Optional</b>				
Hopper 500 g	<input checked="" type="checkbox"/>	<input checked="" type="checkbox"/>	<input checked="" type="checkbox"/>	<input checked="" type="checkbox"/>
Adjustable fork with support	<input checked="" type="checkbox"/>	<input checked="" type="checkbox"/>	<input checked="" type="checkbox"/>	<input checked="" type="checkbox"/>
Metal tamper	<input checked="" type="checkbox"/>	<input checked="" type="checkbox"/>	<input checked="" type="checkbox"/>	<input checked="" type="checkbox"/>
"Red Speed" grinding blades	<input checked="" type="checkbox"/>	<input checked="" type="checkbox"/>	<input checked="" type="checkbox"/>	<input checked="" type="checkbox"/>

(\*) The tolerance on the weight of the dose detected by the weighing system varies proportionally to the increase or decrease in the dose.

(\*) Manufacturer's settings.

## 2.6 Noise level



The maximum noise emission of our grinder-dosers, measured in a UNI EN ISO 3741 reverberation chamber in accordance with EN 60704-1 standards: 1998 and EN 607043:1996. The equivalent noise exposure level for an operator, exclusively related to an appliance operation limit of 240 min over eight hours, is **78 dB(A)**, in accordance with European Directive 86/188/EEC and subsequent revision 2003/10/EEC. Using the appliance does not therefore require any precautions against risks arising from exposure to noise in workplaces (Articles 3-8 of ED 2003/10/EEC).

## 3 SAFETY

### 3.1 General information

The purchaser must inform all personnel of any risks arising from the improper use of the appliance, of the safety devices used by the manufacturer and of the general regulations on accident prevention laid down by EU directives and by the legislation of the country where the appliance is used.

Users must be aware of the location and operation of all controls and machine features specified in this manual.



**ATTENTION!** Before installing, switching on and using the grinder-doser of Fiorenzato M.C. S.r.l. for the first time, you must have read and understood all the contents of this documentation and the “SAFETY INSTRUCTIONS” booklet.



**ATTENTION:** Tampering with or unauthorised replacement of one or more parts of the machine, the use of accessories that alter the use of the machine and the use of non-original spare parts may result in the risk of injury and compromise the proper operation of the machine.



Failure to comply with the above releases Fiorenzato M.C. S.r.l. from any liability for damage to people and/or to property.

### 3.2 Reasonably foreseeable misuse

Fiorenzato M.C. S.r.l. accepts no liability and the warranty will be rendered null and void in the event of negligence when using the machine or failure by the user to comply with the operating instructions in this manual.



Any use of the appliance other than that described in this manual is considered improper.

When using the machine, no other work or activities are permitted which are considered to be improper and which, in general, may involve risks in terms of user safety and/or damage to the machine.

Reasonably foreseeable misuse includes:

- Using the machine for grinding products other than roasted coffee beans (e.g. pepper, salt, etc.).
- Using the appliance with pre-ground coffee.
- Improper use of the appliance by personnel who have not been trained to use it and/or have not read this instruction manual.
- Using spare parts that are not original and/or not specifically for the grinder-doser model in your possession.
- Using the machine in a potentially explosive environment.

In addition, the user must never under any circumstances:

- Attempt to remove any foreign objects that may have accidentally fallen into the coffee feed hopper and/or grinding chamber without first disconnecting the appliance from the mains power supply.
- Use the appliance with wet or damp hands.
- Introduce liquids of any kind into the coffee feed hopper and the grinding chamber.



If the machine is not working properly, any necessary steps are the responsibility of the maintenance technicians.

### 3.3 Precautions for proper and safe use

In order to ensure user safety and to operate the appliance in the best possible way, it is important to comply with some simple but important provisions, namely:

- Avoid improper use of the power cable. Use only cables or extensions with a cross-section suitable for the power installed in the machine.
- Protect the cable from high temperatures, oil and sharp edges.
- Any changes in normal operation (increased power absorption, a rise in temperature, excessive vibration, abnormal noises or alarm signals on the display) indicate improper operation. In order to prevent malfunctioning, which may directly or indirectly cause damage to people or the appliance, ensure you carry out the required maintenance or, if necessary, contact your dealer or a specialised repairer.
- Heavy appliance! Be careful during the phases of transport, handling and installation! Please refer to chapter 4 for proper handling of the appliance.

### 3.4 Safety devices on the grinder-doser



All grinder-dosers manufactured by Fiorenzato M.C. S.r.l. are equipped with appropriate mechanical and electromechanical devices to protect the safety of the user and the integrity/functionality of the appliance during use.

The grinder-dosers in the **XGi** series are equipped with the following safety devices:

- **Motor thermal cut-out:** The motor of the appliance has a thermal cut-out which protects it against overheating due to overcurrents and intervenes by interrupting the power supply to the motor.
- **Cooling fan (Fig. 3):** Only the grinder-doser models F64 EVO and F71 EK have a cooling fan on the back of the machine body to prevent overheating of the grinding blade drive motor. This fan is activated electronically. Start-up is enabled when communication between the coffee grinder and the weight calculation software has terminated.
- **Anti-intrusion device on coffee supply hopper (Fig. 4):** The anti-intrusion device (Part 1) inside the supply hopper (Part 2) allows the coffee beans to pass through to the grinding chamber, preventing operators from accidentally inserting their fingers.

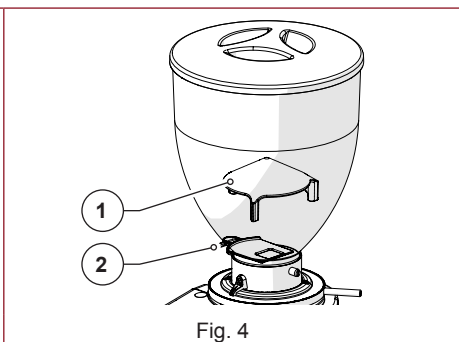
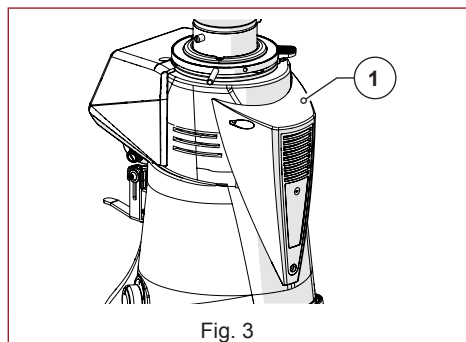

- **Safety adjustment disk lock lever (Fig. 5):** To prevent any accidental rotation of the grinding adjustment disk (Part 1), there is an adjustment disk lock lever (Part 2) which must be pressed to allow rotation.
- **Microswitch for detection of grinding degree variation (Fig. 6):** This microswitch (Part 1), enabled each time the lock lever is pressed (Part 2), is used to inform the control system that a change in the grinding degree may have occurred since the last dose was dispensed and enables the "Dispense dose" mode.

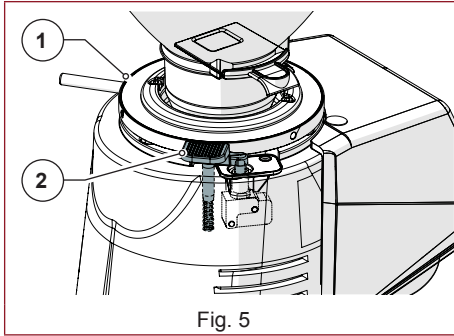

Fig. 5

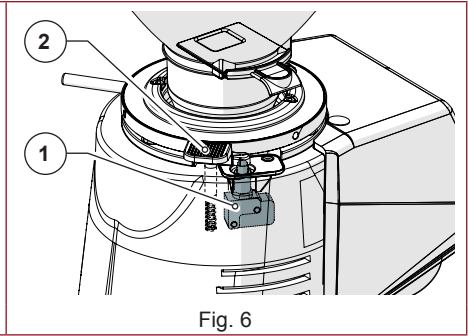



Fig. 6

### 3.5 Residual risks

Fiorenzato M.C. S.r.l. has taken all necessary precautions during the design phase to ensure that the grinder-doser can be used under the safest possible conditions. However, during installation, cleaning and maintenance of the appliance, there are still some residual risks that cannot be eliminated. Their effects can be prevented by appropriately training the user in accordance with the provisions set out in the table below.

For each residual risk, provisions are indicated to limit and/or eliminate the extent of individual risks.

Residual risk	Present during:	Provisions for reducing the risk
 <p><b>Bruising and/or crushing of the upper and lower limbs due to the weight of the appliance.</b></p>	<p>Handling the appliance when:</p> <ul style="list-style-type: none"> <li>• Unpacking.</li> <li>• Installing.</li> <li>• Handling the appliance to clean the surface on which it stands.</li> </ul>	<ul style="list-style-type: none"> <li>• Grip the appliance firmly before handling it.</li> <li>• Make sure you have enough space to handle the appliance safely without hitting any obstacles.</li> <li>• Use non-slip gloves if necessary when handling the grinder-doser.</li> </ul>
 <p><b>Electrocution</b></p>	<ul style="list-style-type: none"> <li>• Connecting and disconnecting the power supply cable.</li> </ul>	<ul style="list-style-type: none"> <li>• Check the condition of the power cable frequently and replace it when it appears to be deteriorated or damaged.</li> <li>• Make sure that the switch is in the “O” (OFF) position before connecting the power cable to the grinder-doser.</li> </ul>

### 3.6 Warning labels attached to the machine

An adhesive label indicating the danger of electrocution is attached to the bottom of the grinder-doser near the power cable (see Fig. 7) The label indicates the presence of live components inside the machine body.



**ATTENTION!** It is forbidden to remove the bottom cover when the plug is connected to the power socket. All electrical maintenance work (e.g. replacement of a damaged cable) must be carried out by qualified technicians when the appliance is disconnected from the mains power supply.

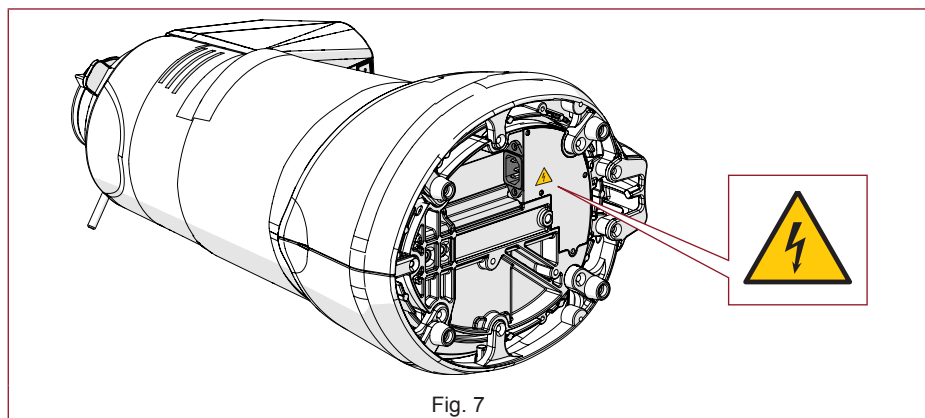

Fig. 7

## 4 INSTALLATION



**ATTENTION!** Please read the following instructions carefully before installing and operating the appliance.

### 4.1 Storage

If the appliance is not immediately installed where it is to be used and it is necessary to store it temporarily, it should be put in a safe place that meets the following requirements:

- the place chosen for temporarily storing the appliance should be a closed environment, protected from the sun and bad weather conditions;
- the temperature of the storage location must be between 5°C and 40°C, with a relative humidity of between 30% and 90%;
- if the appliance is to be stored for a long time before being installed, it should be kept in its original packaging to ensure better protection.



## 4.2 Choosing the installation location

Given the function of the grinder-doser, it is advisable to PLACE IT close to the coffee machine.

Before installing the appliance, please also ensure that the installation location meets the following requirements:

- The surface on which the appliance is to be placed must be flat, well-levelled and strong enough to support its weight;
- the available space must be large enough to allow proper installation and easy use of the appliance;
- the appliance must not be installed near sinks and/or taps, which may cause it to become wet with jets and/or splashes of water;
- The place of use must be sufficiently well-lit and well-ventilated;
- Close to the installation position, there must be a socket, which complies with the regulations in force in the country of use, for connecting the appliance to the mains power supply.



**ATTENTION!** The socket must be equipped with an efficient earthing system.



**ATTENTION!** The mains power supply must also be equipped with a thermal-magnetic circuit breaker located upstream of the socket, in a position known to and easily accessible by the operator in order to protect the appliance from overloads and voltage fluctuations and the user from the risk of electrocution.

## 4.3 Unpacking and handling the appliance

After opening the packaging, carefully check that the appliance is intact and that there are no damaged parts.

- Open the packaging near the point of installation, ensuring that there is enough space to handle the appliance safely.
- Take the appliance out of its packaging, holding it firmly and securely.
- Place the grinder-doser on the worktop.



**ATTENTION!** Take extreme care when handling the appliance. Its weight (18 ÷ 25 kg) and the particular rounded shape of the machine body may lead to the risk of slipping and loss of grip, with possible falling and bruising/ crushing of the feet when lifting and/or of the hands when positioning the appliance on the worktop. If you are not sure you have a secure grip, it is advisable to ask another person to help.



**ATTENTION!** Packaging parts must not be left within the reach of children as they are a potential source of danger. Keep the packaging until the warranty expires.

#### 4.4 Installation and mains connection

To complete installation and start using your new coffee grinder-doser, all you need to do is:

- Ensure that the voltage of the mains power supply meets the required power requirements and that the electrical rating of the system is adequate to support the power absorbed by the appliance (see product identification label on the side of the grinder-doser).
- Put the power cable plug (Fig. 8 Part 1) into the IEC connector on the bottom of the appliance (Fig. 8 Part 2);



**ATTENTION!** To connect the power plug of the grinder-doser to the socket, it is necessary to tilt it completely and place it on one side. Hold the appliance firmly and handle it carefully, taking care not to damage it and not to crush your hands or fingers.



If it is necessary to use power adapters, power strips or extension cables, it is mandatory to use products that comply with the certification standards in force in the country of use.

- Put the grinder-doser back into the upright position and then connect the cable to the power socket provided (Fig. 9).
- If present, set the thermal-magnetic circuit breaker located upstream of the power socket to the “ON” position (Fig. 10).
- Turn the machine power switch to the “I” position (see Part 5.1.1).

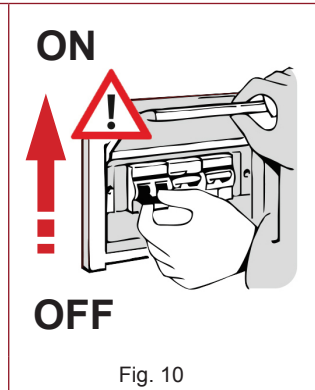
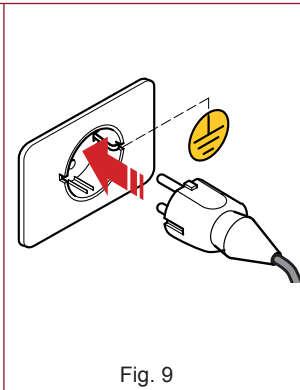
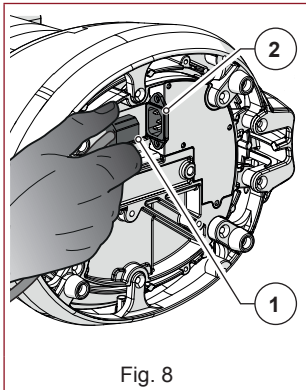

The grinder-doser is now powered and ready for use.

## 5 USING THE GRINDER-DOSER

### 5.1 Machine controls

The grinder-doser is controlled by the On/Off switch (see paragraph 5.1.1) and an operator control panel with a TOUCH-type display, for selecting and setting all the operating functions of the appliance (see paragraph 5.4). All information on the operating status of the appliance, working parameters and commands that can be given are shown on the display on the front of the machine. All the command and signalling devices on the grinder-doser are described below.



The grinder-doser is delivered with a XGi weighing system already correctly calibrated by the manufacturer. The weighing system can only be calibrated again (if required) by the specialised technicians of the manufacturer and/or its authorised retailers, who are in possession of the “Administrator Password”, thereby allowing access to the reserved pages of the grinder-doser management system.

#### 5.1.1 Switch

Switches the appliance on and off.

- Turned to the “O” position: appliance off (power supply disconnected).
- Turned to the “I” position: appliance on (electrically powered).

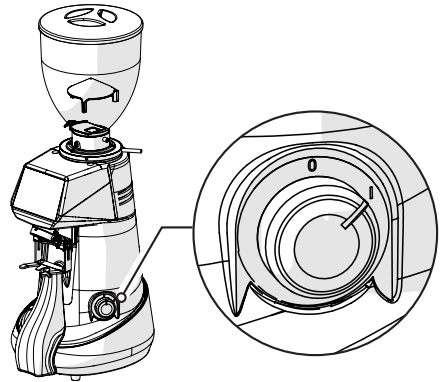

## 5.2 Preparing to use the grinder-doser

When installation has been completed, the machine is ready for use and can be loaded with coffee beans to be ground. With reference to Fig. 11, to load coffee beans it is necessary to:

- Place the hopper (Part 1) on the grinder-doser (Part 2) and lock it into the operating position by tightening the appropriate fastening screw (Part 3).
- Ensure that the locking slide (Part 4) is completely closed.
- Remove the lid (Part 5) and fill the hopper with the roasted coffee beans to be ground.
- Close the hopper with its lid (Part 5).
- Gradually open the locking slide (Part 4) to allow the coffee beans to fall into the grinding chamber.
- Switch on the grinder-doser by turning the appropriate switch to the "I" (ON) position (Part 6).
- After a few seconds, the display shows the "Confirm Start-up" page and waits for the user to carry out the "Initial Start-up" procedure (§5.3) required in order to make the **XGi** weighing system operational, which is enabled by default when the appliance is first switched on.

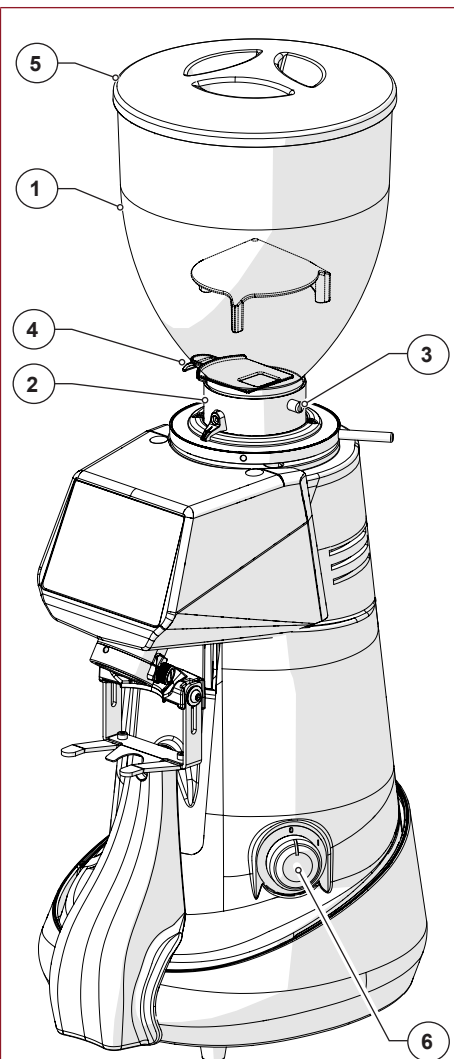
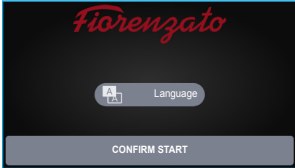
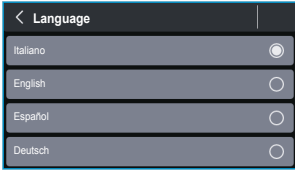

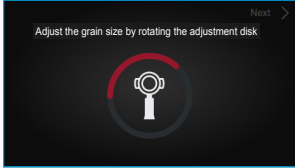



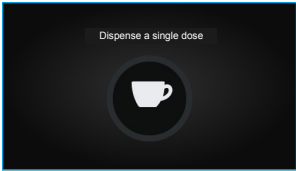

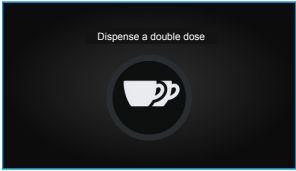

Fig. 11

### 5.3 “Initial start-up” procedure

This is the procedure required to start the grinder-doser for the first time.

At initial start-up, the grinder-doser is configured by default to operate with the enabled **XGi** system. With this procedure, the operator is guided to enter and/or confirm the data required to make the grinder-doser operational.

<ul style="list-style-type: none"> <li>• Check that there is an adequate amount of coffee to grind in the loading hopper. Open the locking slide to feed the grinding blades.</li> <li>• Power up the machine by turning the switch to the “I” position and wait for the operator panel to initialise.</li> <li>• When the “Confirm Start” screen appears, press Language to select.</li> <li>• On the “Language” page, select the required language from those available, then press “Language” to return to the previous page.</li> </ul>	 
<ul style="list-style-type: none"> <li>• Proceed with adjusting the degree of grinding by turning the adjustment disk (see Part 5.5). Alternately adjust the adjustment disk and the coffee dispensing command until the required grain size is reached. Then press down the  button until the progress bar is completely filled. If necessary, you can continue grinding even after the progress bar has been filled.</li> <li>• When the required grain size has been reached, press the “Next” function key to continue.</li> </ul>	
<ul style="list-style-type: none"> <li>• Press “Confirm Start” to switch to the “Change Dose Weight” page.</li> <li>• Set the weight in grams for the single dose.</li> <li>• Set the weight in grams for the double dose.</li> <li>• Press the “Next” button to continue.</li> </ul>	
<ul style="list-style-type: none"> <li>• Wait a few seconds without touching the appliance to allow the weighing system to detect the tare weight.</li> <li>• Wait for the “Dispense single dose” command to appear on the display.</li> </ul>	

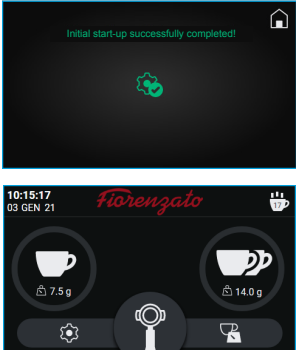
<ul style="list-style-type: none"> <li>Start dispensing a single dose of coffee by pulse pressing the function key shown on the display. The grinding of the single dose of coffee starts and stops when the red progress bar is filled.</li> </ul>	
<ul style="list-style-type: none"> <li>Wait a few seconds without touching the appliance to allow the weighing system to detect the tare weight.</li> <li>Wait for the “Dispense double dose” command to appear on the display.</li> </ul>	
<ul style="list-style-type: none"> <li>Start dispensing a double dose of coffee by pulse pressing the function key shown on the display. The grinding of the double dose of coffee starts and stops when the red progress bar is filled.</li> </ul>	
<ul style="list-style-type: none"> <li>Wait a few seconds without touching the appliance to allow the weighing system to detect the tare weight.</li> <li>Wait for the “Initial start-up successfully completed” message to appear on the display.</li> </ul>	
<ul style="list-style-type: none"> <li>Press the  button to return to the HOME page.</li> <li>You can now use the appliance in “WEIGHT” dispensing mode.</li> </ul>	

## 5.4 Operator control panel

When the grinder-doser is switched on, after a few seconds for the system to start up, the control panel display shows the HOME page, with all the function buttons required to use and manage the appliance.

The management software adopted by Fiorenzato for its coffee grinder-dosers is extremely intuitive to use. This user guide will allow you to quickly become familiar with the function buttons and the various setting options on your new appliance. It has touch-screen panel, which means that functional commands, menu navigation and the setting of preferences and working parameters are carried out with a simple touch of the finger on the sensitive areas of the display.

All the grinder-dosers in the **XGi** series can operate in both the **WEIGHT** (**XGi** automatic weighing system enabled) dispensing mode and the **TIME** (**XGi** automatic weighing system disabled) dispensing mode.

Depending on the type of operation selected, the HOME page (§5.4.1) and certain options in the “Technical Settings” menu (see §5.4.3) will change their appearance from display/setting of grinding parameters expressed in WEIGHT (grams) to display/setting of the same parameters expressed in TIME (seconds). To disable or enable the **XGi** automatic weighing system, see paragraph 5.4.2.

### 5.4.1 Home page

Fig. 12 shows the HOME page with a description of the function buttons and display fields. The HOME page can be customised from the “Settings menu”, therefore the image shown in the figure below may differ from the screen actually displayed on your appliance when it is first switched on.

All the functions accessible from the “Settings menu” are described in the following paragraphs.

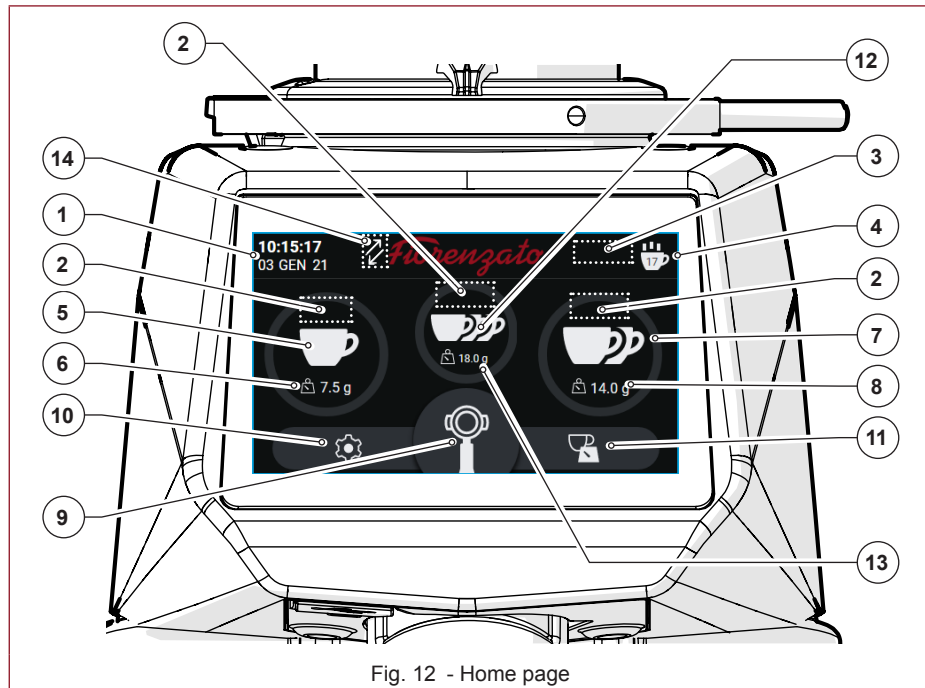













Fig. 12 - Home page



With reference to Fig. 12, the display fields and function buttons on the HOME page are:

	Description
1	Display field for the current date and time. The data can be set by accessing the “ <b>Date and time</b> ” screen from the settings menu (§ 5.4.3.13).



2	<p>In this field, the icons for the operating status of the <b>XGi</b> weighing system (if enabled) are displayed in real time to indicate the conformity or otherwise of the dose dispensed. In particular, the following icons may be displayed:</p> <table border="1" data-bbox="191 231 1039 850"> <tr> <td data-bbox="191 231 269 312"></td> <td data-bbox="269 231 1039 312">Green scales: indicate that the dispensed coffee weight is within tolerance of the weight set for the selected dose (§ 5.4.3.1)</td> </tr> <tr> <td data-bbox="191 312 269 394"></td> <td data-bbox="269 312 1039 394">Yellow scales: indicate that the dispensed coffee weight is not within tolerance of the weight set for the selected dose (§ 5.4.3.1)</td> </tr> <tr> <td data-bbox="191 394 269 558"></td> <td data-bbox="269 394 1039 558">Blue scales: it appears after dispensing two doses that are not within tolerance (yellow scales) to indicate that the <b>XGi</b> system has recalculated the seconds required to dispense the correct doses again. After recalculation, the new dose (third dose) will be dispensed correctly and indicated by the appearance of the “Green Scales” icon.</td> </tr> <tr> <td data-bbox="191 558 269 850"></td> <td data-bbox="269 558 1039 850"> <p>Red scales: It is displayed when the <b>XGi</b> system detects an anomaly in the weighing phase due to the possible addition or removal of weight on the appliance, possible vibrations on the support surface, or connection of the appliance to an unsuitable socket.</p> <p>After three consecutive incorrect doses have been dispensed, the display will show a full-screen control message and the <b>XGi</b> system will perform a forced recalculation of the doses. To perform the recalculation procedure, three doses must be dispensed following the instructions on the display.</p> </td> </tr> </table>		Green scales: indicate that the dispensed coffee weight is within tolerance of the weight set for the selected dose (§ 5.4.3.1)		Yellow scales: indicate that the dispensed coffee weight is not within tolerance of the weight set for the selected dose (§ 5.4.3.1)		Blue scales: it appears after dispensing two doses that are not within tolerance (yellow scales) to indicate that the <b>XGi</b> system has recalculated the seconds required to dispense the correct doses again. After recalculation, the new dose (third dose) will be dispensed correctly and indicated by the appearance of the “Green Scales” icon.		<p>Red scales: It is displayed when the <b>XGi</b> system detects an anomaly in the weighing phase due to the possible addition or removal of weight on the appliance, possible vibrations on the support surface, or connection of the appliance to an unsuitable socket.</p> <p>After three consecutive incorrect doses have been dispensed, the display will show a full-screen control message and the <b>XGi</b> system will perform a forced recalculation of the doses. To perform the recalculation procedure, three doses must be dispensed following the instructions on the display.</p>
	Green scales: indicate that the dispensed coffee weight is within tolerance of the weight set for the selected dose (§ 5.4.3.1)								
	Yellow scales: indicate that the dispensed coffee weight is not within tolerance of the weight set for the selected dose (§ 5.4.3.1)								
	Blue scales: it appears after dispensing two doses that are not within tolerance (yellow scales) to indicate that the <b>XGi</b> system has recalculated the seconds required to dispense the correct doses again. After recalculation, the new dose (third dose) will be dispensed correctly and indicated by the appearance of the “Green Scales” icon.								
	<p>Red scales: It is displayed when the <b>XGi</b> system detects an anomaly in the weighing phase due to the possible addition or removal of weight on the appliance, possible vibrations on the support surface, or connection of the appliance to an unsuitable socket.</p> <p>After three consecutive incorrect doses have been dispensed, the display will show a full-screen control message and the <b>XGi</b> system will perform a forced recalculation of the doses. To perform the recalculation procedure, three doses must be dispensed following the instructions on the display.</p>								
3	<p>Display-only field for any consecutive sequence of doses not within tolerance, incorrect weighing and/or recalculation of the seconds required to correctly dispense the selected dose. In this field, up to two “Yellow Scales” icons, up to three “Red Scales” icons or one “Blue Scales” icon can therefore be displayed depending on the type of weighing performed by the system (i.e. up to two weighing processes not within tolerance, up to three incorrect weighing processes or one weighing process following automatic recalculation of the grinding times).</p> <p>This field also displays the total weight of ground coffee if several doses are dispensed in succession.</p>								
4	<p>“<b>Statistics</b>” button. It controls the opening of the window and shows the number of doses dispensed on the current day and week, and the total number of doses dispensed since the grinder-doser was first used. To close the “Statistics” window, simply press the “Statistics” function button again. The “Statistics” button is only displayed if the “Show statistics” function has been enabled in the settings menu (§ 5.4.3.5).</p>								

5	<p><b>Single Dose Dispensing Button.</b> It enables the dispensing of a single dose of coffee according to the weights set on the “Change dose weight” screen (§5.4.3.1). If the <b>XGi</b> automatic weighing system is not enabled (§ 5.4.2), dosing is carried out on a time basis according to the parameters set in the 'Change dose times' screen (§ 5.4.3.1). Access to the dose time setting page is only possible when the <b>XGi</b> system is not enabled for operation.</p>
6	<p>Display field showing only the weight (or time) of grinding set for the single dose, which can be hidden from the menu.</p>
7	<p><b>Double Dose Dispensing Button.</b> It enables the dispensing of a double dose of coffee according to the weights set on the “Change dose weight” screen (§5.4.3.1). If the <b>XGi</b> automatic weighing system is not enabled (§ 6.1.5), dosing is carried out on a time basis according to the parameters set in the 'Change dose times' screen (§ 5.4.3.1). Access to the dose time setting page is only possible when the <b>XGi</b> system is not enabled for operation.</p>
8	<p>Display field showing only the weight (or time) of grinding set for the double dose, which can be hidden from the menu.</p>
9	<p><b>Manual Grinding Button.</b> Hold-to-run control for dispensing coffee in the manual mode. Coffee grinding starts when the button is pressed and continues until it is released. When the <b>XGi</b> system is enabled, dispensing occurs in grams and the weight is displayed in increments up to a maximum dispensing of 96 grams. When it is not enabled, dispensing occurs in seconds and the time is displayed in increments up to a maximum dispensing of 25 seconds.</p>
10	<p><b>Menu Settings Button.</b> It provides access to the settings menu (§ 5.4.3), which allows the operator to change the various settings and operating modes of the appliance.</p>
11	<p>Shortcut button to access the “<b>Change dose weights</b>” (or “Change dose times”). It allows direct access to the page for setting the weights or dose dispensing times (§5.4.3.1) without using the “Settings menu” (§5.4.3). Access to the dose time setting page is only possible when the <b>XGi</b> system is not enabled for operation.</p>
12	<p><b>Triple Dose Dispensing Button.</b> It enables the dispensing of a triple dose of coffee according to the weights set on the “Change dose weights” screen (§5.4.3.1). If the <b>XGi</b> automatic weighing system is not enabled (§ 5.4.2.1), dosing is carried out on a time basis according to the parameters set in the 'Change dose times' screen (§ 5.4.3.3). Access to the dose time setting page is only possible when the <b>XGi</b> system is not enabled for operation. The function button is only displayed if the “Triple dose display” function has been enabled in the “Settings menu” (§ 5.4.3.6).</p>
13	<p>Display field showing only the weight (or time) of grinding set for the triple dose, which can be hidden from the menu.</p>

14	In this field, two different icons can be displayed:	
		XGi system display icon enabled. This is only displayed when the XGi weighing system is enabled (§5.4.2.2). If the XGi system is disabled, the icon is not shown on the display.
		Warning icon. It only appears at the end of the time set by Fiorenzato to indicate the need to replace the grinding blades (§ 6.1.5).

## 5.4.2 Disabling/Enabling the XGi automatic weighing system

When the appliance is switched on for the first time, the default mode of operation with the automatic weighing of doses is loaded (XGi enabled).

### 5.4.2.1 Disabling the XGi automatic weighing system

To disable the operation of the XGi system and switch to dispensing doses in the TIME mode, it is necessary to press the function key  (see Fig. 12 Part 9) and scroll through the menu until you reach the “XGi SYSTEM” option, then:

- Disable the XGi system by pressing the relevant selector.

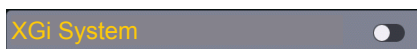



- Press the  function key to return to the HOME page.
- The XGi automatic weighing system has been disabled and the grinder-doser will use the dose dispensing by TIME mode according to the parameters set in the “Change dose time” page of the menu (§ see 5.4.3.1).

### 5.4.2.2 Activation of the XGi automatic weighing system

To enable the operation of the XGi system and switch to dose dispensing by WEIGHT mode, it is necessary to press the function key  (see Fig. 12 Part 9) and scroll through the menu until you reach the “XGi SYSTEM” option, then:

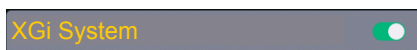
- Enable the XGi system by pressing the relevant selector.



- Press the  function key to return to the HOME page.
- The XGi automatic weighing system has been enabled again and the grinder-doser will ask you to perform the 'Initial start-up' procedure (see §5.3) to calibrate the appliance before it can dispense the doses again by WEIGHT using the parameters set on the “Change grinding weights” page of the menu (§ see 5.4.3.1).

### 5.4.3 Settings Menu

The 'Settings menu' allows you to set and adjust all the parameters and operating modes of your grinder-doser.

The Settings menu is accessed by pressing the  function button, always visible in the bottom left-hand corner of the display (see Fig. 12 Part 9). Once the command has been given, the display will load the menu, allowing you to select the parameter to be changed and/or the function to be enabled/disabled by simply scrolling down the list of possible options until you find the option you require.

As already described in paragraph 5.4, some options in the “Settings” menu change according to the type of dose dispensing selected (by WEIGHT or by TIME). Below are the menus displayed for an **XGi** enabled system (dosing by WEIGHT) and a **XGi** disabled system (dosing by TIME). Each option in the two menus is associated with a reference to the paragraph describing the individual function/screen.

#### Settings menu with **XGi** enabled system (dose dispensing by WEIGHT):

##### Technical Settings

- Change grinding weights (§ 5.4.3.1)
- Dose weight display (§ 5.4.3.2)
- Show statistics (§ 5.4.3.5)
- Triple dose display (§ 5.4.3.6)

##### XGi Settings

- XGi system (§ 5.4.3.7)
- Initial start-up (§ 5.4.3.8)

##### User Settings

- Display brightness (§ 5.4.3.9)
- Screen appearance (§ 5.4.3.10)
- Screensaver (§ 5.4.3.11)
- Language (§ 5.4.3.12)
- Date and time (§ 5.4.3.13)
- Information (§ 5.4.3.14)

##### Safety Settings

- Reset dose weights (§ 5.4.3.15)
- Administrator password (§ 5.4.3.16)

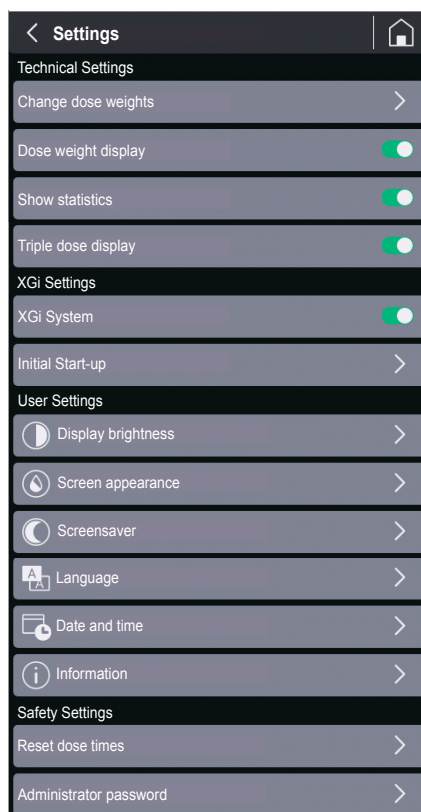

## Settings menu with a XGi disabled system (dose dispensing by TIME):

**Technical Settings**

- Change dose times (§ 5.4.3.3)
- Grinding time display (§ 5.4.3.4)
- Show statistics (§ 5.4.3.5)
- Triple dose display (§ 5.4.3.6)

**XGi Settings**

- XGi system (§ 5.4.3.7)
- Initial start-up (*Disabled*)

**User Settings**

- Display brightness (§ 5.4.3.9)
- Screen appearance (§ 5.4.3.10)
- Screensaver (§ 5.4.3.11)
- Language (§ 5.4.3.12)
- Date and time (§ 5.4.3.13)
- Information (§ 5.4.3.14)

**Safety Settings**

- Reset dose times (§ 5.4.3.15)
- Administrator password (§ 5.4.3.16)

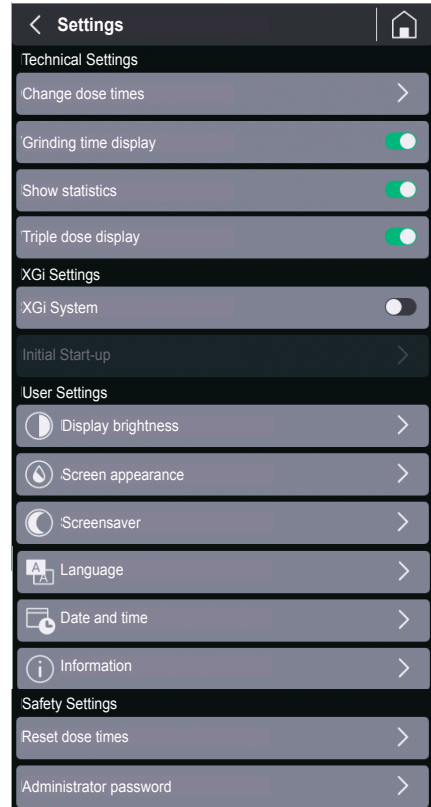

### 5.4.3.1 Change grinding weights

By pressing the “Change grinding weights” option in the “Technical Settings” when the **XGi** system is enabled (see § 5.4.2.2), you can access the page for setting the grinding weights for a single, double and triple dose.

**N.B.** The triple dose grinding time is only displayed if the “Triple dose display” option has been enabled in the Settings menu (§ 5.4.3.6).

Use the function buttons **+** or **-** to increase or decrease dispensing times.

The changed parameters are saved automatically when exiting the page.

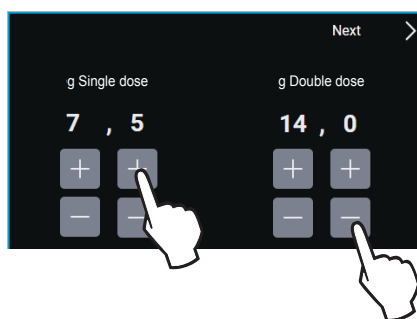

### 5.4.3.2 Dose weight display

With the **XGi** system enabled (see §5.4.2.2), by enabling the “Grinding time display” option in the “Technical Settings” menu (☑️), the weights set for dispensing the different doses are displayed on the HOME page.

During dispensing, the button icon for the selected dose starts to gradually turn red until it is completely filled, thus displaying the current grinding phase. For manual grinding, the weight is displayed to increase up to a dispensing dose of maximum 96 grams, at which point grinding is automatically stopped. If the “Grinding weight display” option is disabled (🚫), the dispensing weights are not displayed on the HOME page.



HOME page with visible dose weights

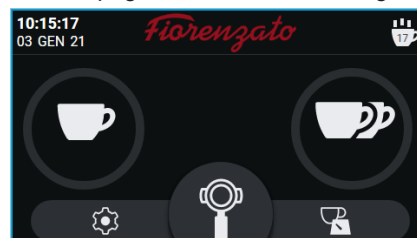

HOME page without visible dose weights

### 5.4.3.3 Change dose times

By pressing the “Change dose times” option in the “Technical Settings” menu when the **XGi** system is disabled (see § 5.4.2.1), you can access the page for setting the grinding times for a single, double and triple dose.

**N.B.** The triple dose grinding time is only displayed if the “Triple dose display” option has been enabled in the Settings menu (§ 5.4.3.6).

Use the function buttons **+** or **-** to increase or decrease dispensing times.

The changed parameters are saved automatically when exiting the page.

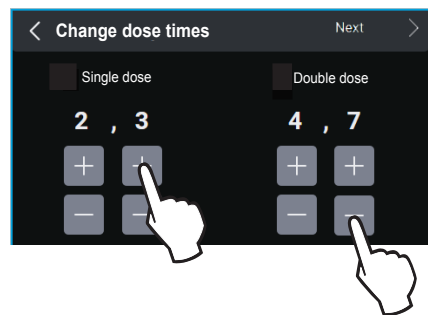

### 5.4.3.4 Grinding time display

With the **XGi** system disabled (see § 5.4.2.1), by enabling the “Grinding time display” option in the “Technical Settings” (☑), the times set for dispensing the different doses are displayed on the HOME page.

During dispensing, the button icon for the selected dose starts to gradually turn red until it is completely filled, thus displaying the current grinding phase. For manual grinding, the time is displayed to increase up to a dispensing dose of maximum 25 seconds, at which point grinding is automatically stopped.

If the “Grinding time display” option is disabled (☐), the dispensing times are not displayed on the HOME page.

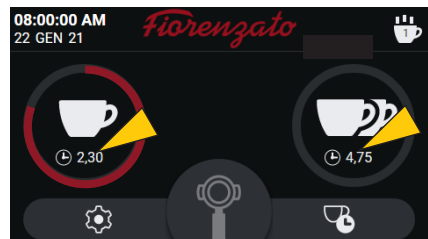

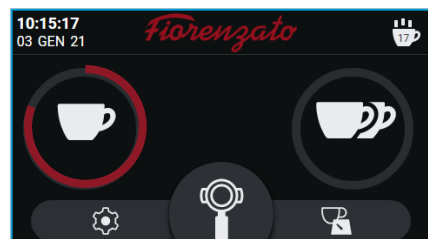

HOME page with grinding times displayed



HOME page without grinding times displayed

### 5.4.3.5 Show statistics



It enables  or disables  the “Statistics” function button display on the HOME screen (see Fig. 12 Part 4).

**N.B.** The dispensed dose count is increased and stored in the memory even if the “Show statistics” option is disabled.



HOME page with “Statistics” button disabled

### 5.4.3.6 Triple dose display

It enables  or disables  the display and management of the triple dose dispensing function button from the HOME page.

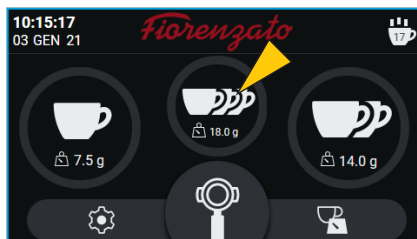

HOME page with “Triple dose” button enabled



### 5.4.3.7 XGi System

It allows you to enable (🔘) or disable (🔘) the **XGi** automatic dose weighing system.

- When the **XGi** system is enabled, the grinder-doser works by dispensing doses according to the set weights (§5.4.3.1).
- When the **XGi** system is disabled, the grinder-doser works by dispensing standard On Demand doses according to the set times (§5.4.3.3).

**N.B.** Each time the “XGi System” is enabled again, you are requested to follow the “Initial start-up” procedure (§5.4.3.8 and §5.3) required to calibrate the weighing system.



Home page with “XGi System” enabled (dosing by WEIGHT)



Home page with “XGi System” disabled (dosing by TIME)

### 5.4.3.8 Initial start-up

The “Initial start-up” procedure is requested automatically when the appliance is switched on for the first time and each time the **XGi** automatic weighing system is enabled again (§ 5.4.3.7).

The operating sequence of the “**Initial start-up**” procedure is described in paragraph 5.3.

**N.B.** If the “**XGi** System” is enabled, the “Initial start-up” procedure can be carried out at any time, if required.

**N.B.** If the “**XGi** System” is disabled, the 'Initial start-up' option is not enabled and is displayed in grey.

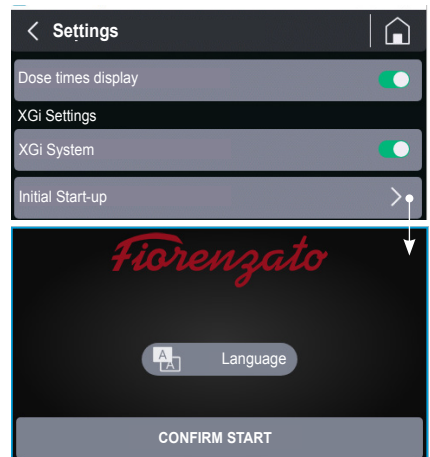

First page for “Initial start-up” procedure

### 5.4.3.9 Display brightness

When you select the “Display brightness” option, you can access the screen shown in the figure, using it to increase or decrease the brightness of the screen by simply moving the adjustment cursor to the right (increase) or to the left (decrease).

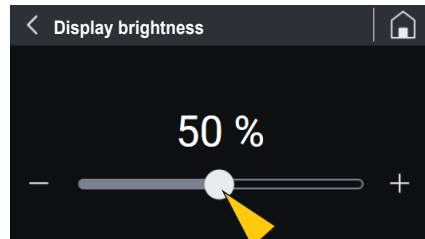

HOME page with “Triple dose” button enabled

#### 5.4.3.10 Screen appearance

When you select the “Screen appearance” option, the screen shown in the figure below opens, and you can choose whether to display the screens in “Dark mode” or “Light mode”.



The different way in which the screens are displayed does not affect other options and/or the various parameters that can be set.



HOME page: “Black version”

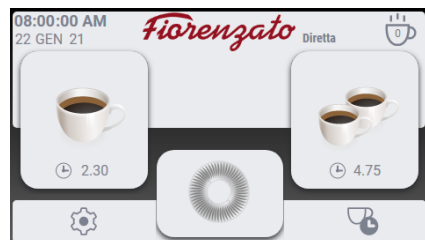

HOME page: “White version”

### 5.4.3.11 Screensaver

When you select the “Screensaver” option, you can access the screen shown in the figure and use it to enable (🟢) or disable (🟡) the function of the same name and select the duration of stand-by after which it is to be started up.

The start of the screen saver can be set after the appliance has been on stand-by for 20 secs, 45 secs or 5 minutes.

When enabled, and after the selected time has elapsed, the display enters the energy-saving mode, showing only the manufacturer's logo and the current date and time.

After 15 minutes of stand-by, the screen switches off.

To exit power-saving or screen saver mode, simply touch the display.

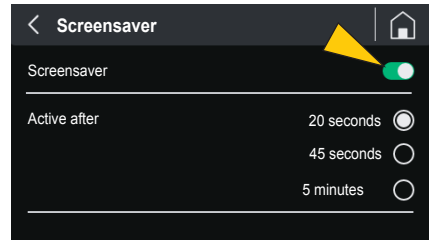

HOME page with “Triple dose” button enabled

### 5.4.3.12 Language

Select “Language” to access the screen where you can set the language on the display. Once the chosen language has been selected, all menus and function buttons will be displayed in the required language.

The available languages are:

- Italian
- English
- French
- German
- Spanish
- Portuguese
- Greek
- Croatian
- Arabic
- Chinese
- Korean

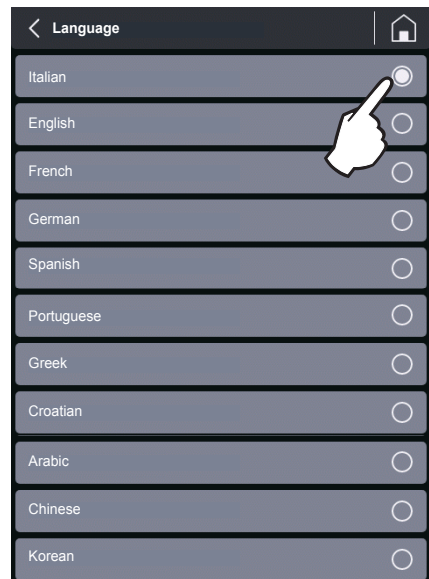



Language selection

### 5.4.3.13 Date and time

The “Date and Time” option allows the current date and time setting page to be loaded.

The two selectors () are for setting the time to the 24 or 12-hour clock. For the 12-hour clock, the time band “AM” (Ante meridiem) or “PM” (Post meridiem) must be specified to allow the system to update the date correctly at midnight.

To adjust the time (hours and minutes) or the date (day/month/year), simply press (single tap or hold) the function buttons  or .

N.B. The setting is stored in the memory in real time, so when you exit the menu, the HOME page will display the correct date and time.

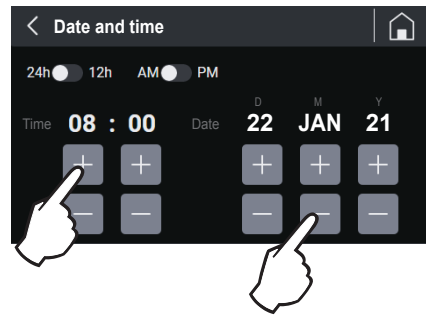

Date and time adjustment

### 5.4.3.14 Information

Selecting the “Information” option from the Settings menu will take you to the page shown in the figure below, where you will find the following information:

- The version of the Firmware installed on the panel;
- The serial number of the panel installed on the appliance;
- The total number of doses dispensed since the appliance was first used;
- The general counter showing the total time the appliance is actually running (working time of the grinding blade drive motor).

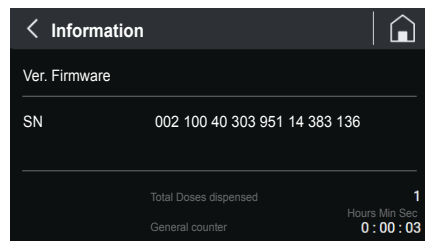

“Information” page

### 5.4.3.15 Resetting dose weights

The “Reset dose weights” option allows you to access the reset page illustrated in the figure, so the user can reset customised dose weights and restore the factory parameters set by the manufacturer.

**Warning:** The “Reset dose weights” command is irreversible and results in the loss of the user's customised dose dispensing weights. To prevent accidental loss of the set weights, the system will ask the user to confirm the action by pressing the “YES, CONFIRM” button before restoring the weights set by the manufacturer.

If you return to the menu [ < ] or load the HOME page [ 🏠 ] without confirming the Reset action, the customised weights will be stored in the memory.

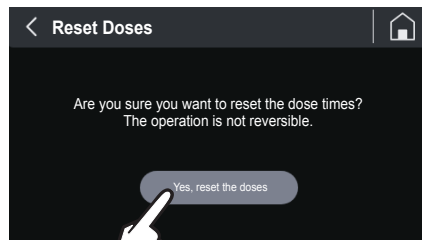

Resetting dose weights

### 5.4.3.16 Administrator password

When you press the “Administrator password” option (last option in the “Settings menu”), the authentication page is loaded, shown in the figure, which allows only authorised technicians to access the reserved pages containing particular settings and functions for initialising the appliance.

**N.B.** The numerical authentication password is not given to the end user but only to the manufacturer's specialised technicians and authorised dealers.

In this menu, the following options are available:

- enable change in dose weights
- enable display of dose weights
- manual grinder
- enable custom logo
- total reset of statistics
- grinding blade counters
- initialisation
- scales calibration
- scales check

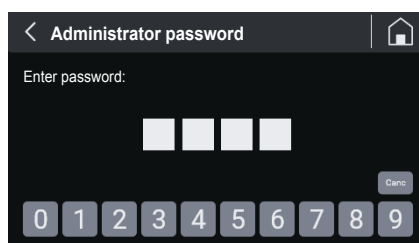

Authentication for access to password-protected pages

## 5.5 Adjusting the degree of grinding

To grind coffee more or less finely, adjust the grinding adjustment disk (Part 1) located under the hopper (Part 2).

Adjustment should only be carried out during the grinding phase. We recommend carrying out adjustment when dispensing a double dose of coffee.

To change the grain size, it is necessary to:

- Start grinding the double dose;
- Press and hold the adjustment disk lock lever (Part 3);
- Turn the adjustment disk clockwise for coarser grinding;
- Turn the adjustment disk anti-clockwise for finer grinding.
- Release the lever (Part 3) to lock the adjustment disk in the new position.

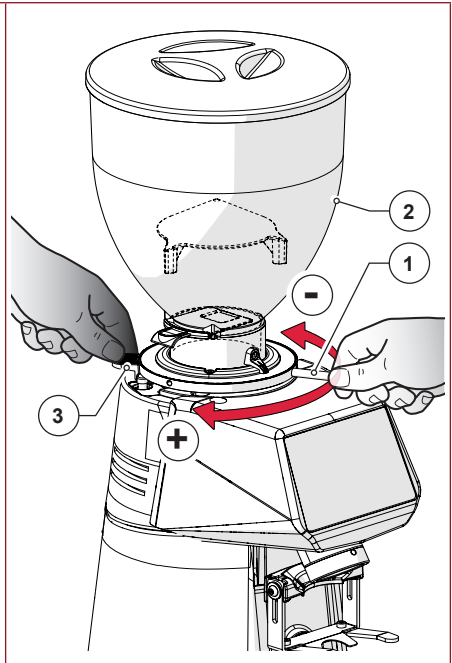

## 5.6 XGi system auto-calibration

Each time the adjustment disk lock lever is pressed and/or each time the dose weight (§5.4.3.1) is changed, the message “DISPENSE DOSE” appears on the HOME page and the XGi system will oblige the user to follow the guided procedure for a forced recalculation of the doses.

The following three dispensing operations are used to recalculate the grinding time required to dispense the set weight of the doses.

After the third dispensing operation, the appearance of the icon  (blue scales) on the display will indicate that the compulsory recalculation of doses has been carried out and that the weights subsequently dispensed will be within tolerance of the set nominal weights.

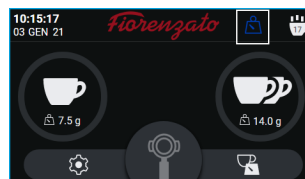
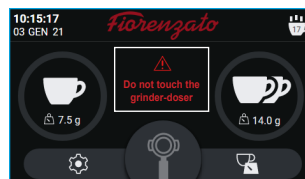





x 3



Forced recalculation of dispensing times



## 5.7 Dispensing doses

With the grinder-doser ready to use, simply place the filter cup holder (Part 1) on the special support fork (Part 2) and press the ,  or  buttons to dispense the required dose.

You can also press the  button to start continuous grinding of coffee. Continuous dispensing stops automatically when the  button is released.

When the ,  or  buttons are pressed, the grinder-doser will dispense doses according to the enabled operating mode:

- Dispensing by WEIGHT (with the XGi System enabled, default mode enabled).
- Dispensing by TIME (with the XGi System disabled).

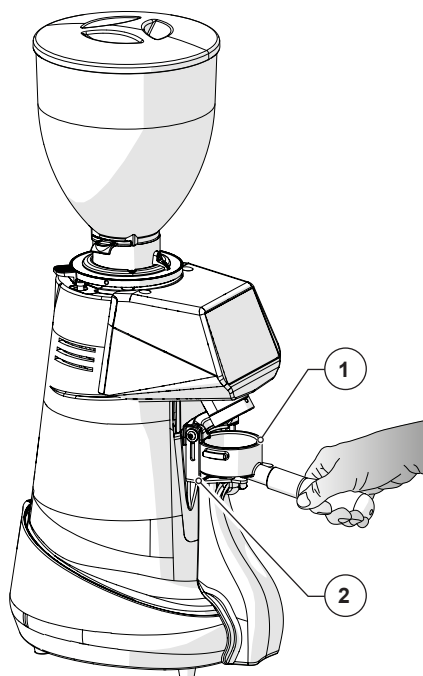



## 6 GRINDER-DOSER MAINTENANCE

### 6.1 Routine maintenance



**ATTENTION!** Before carrying out any routine maintenance work on the grinder-doser, disconnect it from the power supply by turning the power switch (Fig. 13) to the “O” (OFF) position and disconnect the power plug from its socket (Fig. 14).

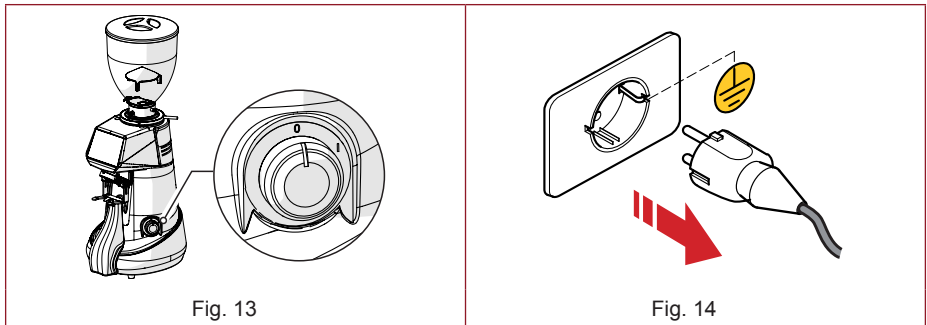

All routine maintenance for your appliance is summarised in the table below.

Fiorenzato M.C. S.r.l. recommends that customers strictly follow the instructions given and carry them out within the stated times and as described.

ROUTINE MAINTENANCE WORK			
Frequency	Type of intervention	Implemented by	Par.
At the end of every shift	Thorough cleaning of the appliance	User	6.1.1
At the end of every shift	Checking the power cable status	User	6.1.2
Every month	Thorough cleaning of the grinding blades	User	6.1.3
When necessary	Shutting down the Grinder-doser	User	6.1.4
On the set deadline (indicated on the “HOME” page by the appearance of the “  ” icon to the left of the logo).	Replacing the grinding blades	Qualified operator or specialised technician	6.1.5

### 6.1.1 Cleaning the appliance

**AT THE END OF EVERY SHIFT:** Thoroughly clean the appliance.

- Close the locking slide (Part 1), loosen the fastening screw (Part 2) and remove the hopper (Part 3) from the appliance.
- Remove the lid (Part 4) from the hopper and empty out the coffee beans inside it. We recommend that you pour the coffee back into the original bag and seal it hermetically to preserve the aroma.
- Clean the inner and outer surfaces of the hopper using warm water and a pH-neutral, unscented, degreasing and cleaning agent specifically for use in the food industry. Do not use abrasive sponges and/or aggressive detergents that may damage the hopper surfaces.
- Thoroughly dry the washed parts with a soft, dry cloth.



**ATTENTION!** The hopper cannot be washed in a dishwasher.

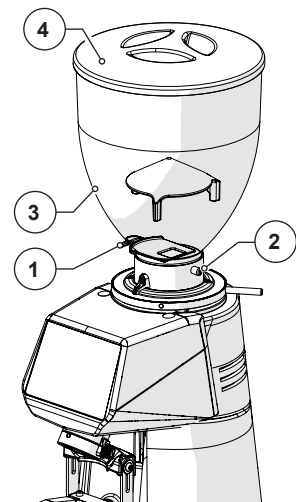

- Using a soft-bristled brush (clean and sanitised) and a vacuum cleaner, remove the coffee beans and coffee powder residue from the grinding chamber (Part 1).



**ATTENTION!** Do not use water and/or detergents to clean the grinding chamber and grinding blades.

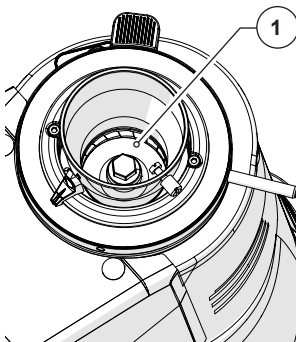

- Loosen the fastening screw (Part 1) and pull out the coffee discharge tube (Part 2) from its position.
- Wash the tube with warm water and a pH-neutral, unscented, degreasing and cleaning agent specifically for use in the food industry.
- Wipe dry with a soft cloth.
- Using a vacuum cleaner and a dry cloth, clean all coffee powder residues from the discharge tube housing.

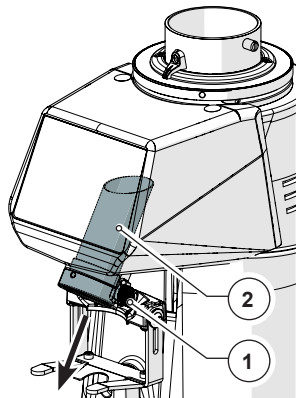

- The exterior of the machine body must be cleaned using soft cloths and products suitable for use in the food industry.



**ATTENTION!** Do not use abrasive sponges and/or aggressive products that may damage the external surfaces of the machine.



**ATTENTION!** It is forbidden to use water or steam jets to clean the machine body.

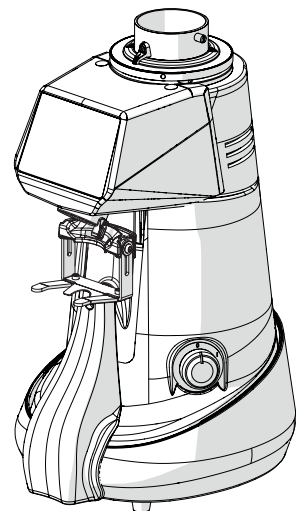

- After cleaning, reassemble the machine, put the discharge tube (Part 1) back into place (Part 2) and secure it by tightening the screw (Part 3).
- Place the hopper (Part 4) and secure it with the appropriate screw (Part 5).
- Close the hopper with its lid (Part 6).

The machine is ready to be used again after being fed and filled with coffee beans.

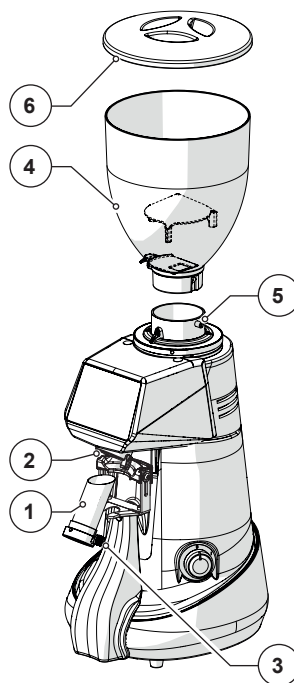

### 6.1.2 Checking the power cable status

**AT THE END OF EVERY SHIFT:** check the power supply cable.

- Disconnect the cable from the power socket, check visually and by touching that the protective sleeve is intact, that the wires are not exposed and that the plug is not damaged.



**ATTENTION!** If the power cable is damaged, replace it with one of the same type.

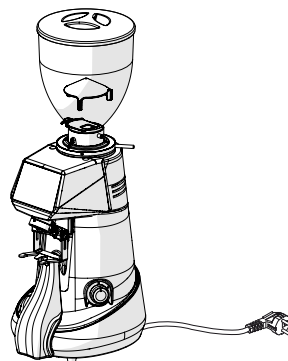

### 6.1.3 Thoroughly cleaning the grinding blades

**EVERY MONTH:** thoroughly clean the grinding blades

The grinding blades should be thoroughly cleaned once a month (or when necessary), using specific cleaning products for grinder-dosers, which are readily available on the market (e.g. PULY GRIND coffee grinder cleaner).

- Thorough cleaning must be carried out after the end-of-shift cleaning. No coffee must be in the machine and the supply hopper must not be attached.
- The grinding blades can be cleaned by pouring a dose of the product into the (completely empty) grinding chamber and starting the grinding process. During grinding, the product (in grains or crystals) regenerates the grinding blades by completely removing all coffee, scale, mould and greasy deposits from their surfaces, absorbing oil and destroying any rancid deposits without leaving any residues.
- In this way, regeneration takes place without the need to disassemble the grinding blades and without having to change the set grinding position.

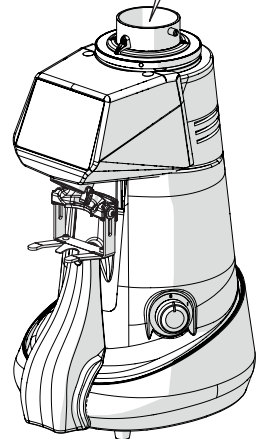

### 6.1.4 Shutting down the grinder-doser

If the machine is not used for long periods of time (e.g. festive periods, holidays, etc...), we recommended carrying out the following cleaning operations to keep it in good condition and avoid any potential problems when restarting it.

**WHEN NECESSARY:** cleaning and shutting down the machine.

- The grinder-doser should be thoroughly cleaned as described in Par. 6.1.1.
- Thoroughly clean the grinding blades as described in Par. 6.1.3.
- Disconnect the power supply cable from the power socket.
- Cover the machine with a cloth to prevent any accumulation of dust and dirt.

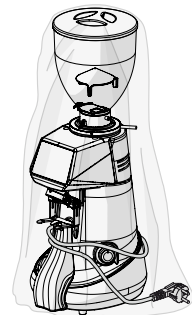

### 6.1.5 Replacing the grinding blades

The scheduled deadline for replacing the grinding blades is set by Fiorenzato M.C. S.r.l. depending on the type of grinders and the grinder-doser model.

At the end of the time set by the manufacturer, the warning icon “” appears on the display, indicating that they need to be replaced.





**ATTENTION!** Replacement of the grinding blades must be entrusted to a specialised technician or the manufacturer's authorised dealer, who will replace them with original spare parts. When replacement has been completed, the qualified operator/dealer in possession of the “Administrator Password” (§5.4.3.16) for accessing the “Safety Settings” menu will also reset the grinding blade counters, check the accuracy of the scales and, if required, calibrate them again.









## 6.2 Supplementary maintenance

There are no scheduled supplementary maintenance operations for the grinder-doser. However, in the event of breakages and/or malfunctioning not covered in the section “7 ANOMALIES - CAUSES - REMEDIES”, do not intervene on the appliance yourself but inform your local dealer who will contact the Fiorenzato M.C. S.r.l. service department to solve the problem.



## 7 ANOMALIES - CAUSES - REMEDIES

The table shows possible faults that may cause the grinder-doser not to work and/or not to function properly. For each anomaly, the possible cause is indicated along with the actions to be taken to restore the correct operation of the appliance.

Anomaly	Cause	Remedy
The grinder-doser does not switch on.	No power supply.	<ul style="list-style-type: none"> <li>Make sure that the switch is in the "I" (ON) position;</li> <li>Make sure that the thermal-magnetic circuit breaker upstream of the socket (if present) is in the "ON" position.</li> <li>Make sure that the power cable is intact and correctly connected to the power plug and the socket on the appliance.</li> </ul>
The coffee beans do not fall out of the supply hopper.	Locking slide closed.	<ul style="list-style-type: none"> <li>Open the locking slide.</li> </ul>
The system loses data from previous settings when it is switched on.	The backup battery of the machine management system is flat.	<ul style="list-style-type: none"> <li>Contact the service department to replace the backup battery.</li> </ul>
The  icon (Yellow scales) appears on the display to indicate that the weight of the last dose dispensed was not within tolerance of the set weight.	<ul style="list-style-type: none"> <li>First daily doses</li> <li>A change in the type of coffee in the hopper</li> <li>Coffee with a high percentage of robusta</li> <li>Grinding blades not well-tuned yet</li> </ul>	<ul style="list-style-type: none"> <li>Dispense further doses without changing any settings on the appliance.</li> <li>After two doses in succession not within tolerance, the XGi software automatically calculates the seconds required to correctly dispense the set dose. Notification of recalculation is indicated by the appearance of the  icon (Blue scales).</li> <li>The doses dispensed after recalculation will be correct and will be indicated by the appearance of the  icon (Green scales).</li> </ul>

Anomaly	Cause	Remedy
<p>The  icon (Red scales) appears on the display to indicate that a fault has occurred in the weighing of the last dose dispensed.</p>	<ul style="list-style-type: none"> <li>• Possible addition (or removal) of weight on the appliance during the dispensing/ dose weighing cycle.</li> <li>• The appliance is placed on an unstable work surface that affects the correct detection of weight.</li> <li>• The appliance is connected to an unsuitable power strip.</li> </ul>	<ul style="list-style-type: none"> <li>• Make sure that the appliance is placed on stable, vibration-free surface.</li> <li>• Check and/or replace any power strip to which the device is connected.</li> <li>• Dispense further doses until the  icon (Green scales) indicates that the dose dispensed is correct.</li> <li>• After the third incorrect dose in succession (    - three “Red scales” icons appear on the display), the following message of control appears full screen:           <div data-bbox="628 708 972 908" style="background-color: black; color: red; padding: 10px; margin: 10px 0;"> <p style="text-align: center;">&lt; </p> <p style="text-align: center;">Attention!</p> <p style="text-align: center;">Carry out a perimeter control of the grinder-doser. If the problem persists, reset the dose from the menu. SETTINGS MENU &gt;&gt; RESETTING DOSES</p> </div> </li> </ul> <p>After returning to the HOME page, the XGi system enables the sequence for the forced recalculation of the doses and it will be necessary to dispense three doses following the instructions on the display in order to allow the XGi system to perform the recalculation. Notification of successful recalculation is indicated by the appearance of the icon  (Blue scales). The doses dispensed after recalculation will be correct and will be indicated by the appearance of the  icon (Green scales).</p>



Anomaly	Cause	Remedy
<p>After dispensing, the message “Weight detection error” appears full screen.</p> 	<ul style="list-style-type: none"> <li>• A foreign body is placed on the appliance and the XGi system fails to detect the tare weight.</li> <li>• The appliance is subjected to vibrations and/ or strong air currents.</li> <li>• Possible foreign body between the curved protective elements and the machine body.</li> </ul>	<ul style="list-style-type: none"> <li>• Check the perimeter of the grinder-doser and remove any objects that may be placed on the appliance.</li> <li>• Make sure that the grinder-doser is not subject to vibrations from other appliances (e.g. dishwashers, blenders, juicers, etc.) or strong air currents from, for example, a fan.</li> <li>• Check and remove foreign bodies from the curved protective elements of the appliance using a fine brush, a suction device or a folded piece of paper.</li> </ul>
<p>The icon “” appears on the display accompanied by an alert message about the need to replace the grinding blades.</p>	<p>The grinding blades are close to the manufacturer’s working hour limit and therefore their replacement must be planned.</p>	<ul style="list-style-type: none"> <li>• The grinder-doser can be used until the set time limit is reached. When the time limit has been reached, the grinding blades must be replaced in order to guarantee maximum machine efficiency, following the instructions given in paragraph 6.1.5.</li> <li>• Once they have been replaced, the specialist technician resets the time counter for the grinding blades.</li> </ul>

Anomaly	Cause	Remedy
During grinding the motor stops.	Triggering of the motor thermal-magnetic circuit breaker due to blockage of the grinding system if objects or foreign bodies are between the grinding blades.	<ul style="list-style-type: none"><li>• Switch off the appliance and wait until it has cooled down completely.</li><li>• Disconnect the appliance from the mains power supply.</li><li>• Close the locking slide and remove the supply hopper.</li><li>• Clean the grinding chamber and remove any foreign bodies.</li><li>• Reassemble the appliance and start a grinding cycle.</li></ul>



**ATTENTION!** If the anomaly persists even after carrying out the recommended corrective actions, or if functional anomalies occur that are not indicated in the table, contact your local dealer, who will decide whether to contact the Fiorenzato M.C. S.r.l. service department or have the appliance repaired or overhauled by a specialised technician.

## 8 REQUESTING SPARE PARTS

If it is necessary to replace worn parts of the grinder-doser (e.g. grinding blades), the end user (e.g. bartender/restaurateur, etc.) must contact their local distributor, a direct intermediary with Fiorenzato M.C. S.r.l., and communicate the grinder-doser model in their possession for identification and to request the supply of original spare parts. Only authorised local distributors will then be given the opportunity to register on our website to order the required spare part.

To request spare parts, local distributors must:

- Visit [www.fiorenzato.com](http://www.fiorenzato.com), enter the spare parts section and select the grinder-doser model indicated by the end user.
- Access the reserved area by entering their credentials on the form provided (at the first login, they must register by entering their identification data).
- Select the necessary spare parts using the exploded view tables of the product on the portal.
- Follow the guided procedure to complete their order and send it to Fiorenzato M.C. S.r.l..
- The local distributor will be contacted by personnel of Fiorenzato M.C. S.r.l., who will take care of the request.



**ATTENTION!** Please note that the replacement of grinding blades and, in general, of all internal parts of the grinder-doser must be carried out by specialised technicians.



**ATTENTION!** Fiorenzato M.C. S.r.l. is not liable for any personal injury and/or damage to the appliance caused by the replacement of components with non-original spare parts by unqualified persons.

*Fiorenzato*

**Fiorenzato M.C. S.r.l.**

Via Rivale, 18 - Santa Maria di Sala (VE) - ITALY

Tel. +39/049 628716 - Fax. +39/049 8956200

info@fiorenzato.it - www.fiorenzato.it